

Service Manual

Amplifier

Amplifier

SE-CH530

Colour

(K) : Black

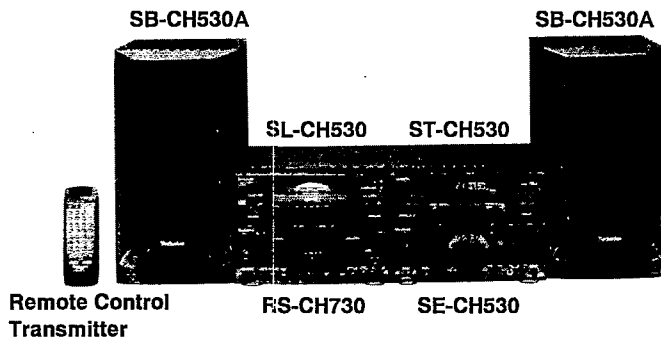
Remote Control
Transmitter

RS-CH730

SE-CH530

Because of unique interconnecting cables, when a component requires service, send or bring in the entire system.

Areas

Suffix for Model No.	Area	Colour
(E)	Europe	(K)
(EB)	Britain	
(EG)	Germany and Italy	
(EP)	Eastern Europe and Poland	

System: SC-CH530

Specifications

Power output

[For (E), (EG) and (EP) areas]

DIN 1 kHz, THD 1%, both channel driven

2 × 35 W (6 Ω)

[For (EB) area]

RMS 1 kHz, THD 10%, both channel driven

2 × 48 W (6 Ω)

Total harmonic distortion

Rated power at 1 kHz

1% (6 Ω)

Half power at 1 kHz

0.09% (6 Ω)

Load impedance

6 Ω – 8 Ω

S/N (rated power)

90 dB

Frequency response

40 Hz – 30 kHz

■ General

Power consumption

114 W

Power supply

[For (E), (EG) and (EP) areas] 230 V, AC 50/60 Hz

[For (EB) area] 230 – 240 V, AC 50/60 Hz

Dimensions (W × H × D)

270 × 118.5 × 341.5 mm

Weight

4.2 kg

Notes:

Specifications are subject to change without notice.

Weight and dimensions are approximate.

Total harmonic distortion is measured by the digital spectrum analyzer.

System	Tuner/sound processor	Compact disc player	Amplifier	Cassette deck	Speakers
SC-CH530	ST-CH530	SL-CH530	SE-CH530	RS-CH730	* SB-CH530A

* Made in PAES

⚠ WARNING

This service information is designed for experienced repair technicians only and is not designed for use by the general public. It does not contain warnings or cautions to advise non-technical individuals of potential dangers in attempting to service a product.

Products powered by electricity should be serviced or repaired only by experienced professional technicians. Any attempt to service or repair the product or products dealt with in this service information by anyone else could result in serious injury or death.

Technics®

© 1995 Matsushita Electric Industrial Co., Ltd.
All rights reserved. Unauthorized copying
and distribution is a violation of law.

■ Contents

	Page		Page
Before Repair	2	Power Source ON/OFF of This Unit	11
Protection Circuitry	2	Schematic Diagram	11~13
Accessories	2	Printed Circuit Board Diagram	14~16
Caution of AC Mains Lead	3	Wiring Connection Diagram	16
Stacking the Components	4	Block Diagram	17
Connections	4~7	Replacement Parts List	18~20
Optional Antenna Connections	7	Cabinet Parts Location	21
External Unit Connection	8	Packaging	22
Location of Controls	8		
Operation Check and Main Component Replacement Procedures	9, 10		

■ Before Repair

- (1) Turn off the power supply. Using a 10 Ω, 10 W resistor, connect both ends of power supply capacitors (C701, C702) in order to discharge the voltage.
- (2) Before turning the power supply on, after completion of repair, slowly apply the primary voltage by using a power supply voltage controller to make sure that the consumed current at 50/60 Hz in NO SIGNAL mode should be shown below with respect to supply voltage 230 V/240 V.

Power supply voltage	AC 230 V	AC 240 V
Consumed current 50 Hz	60 ~ 200 mA	60 ~ 200 mA

■ Protection Circuitry

The protection circuitry may have operated if either of the following conditions is noticed:

- * No sound is heard when the power is switched ON.
- * Sound stops during a performance.

The functions of this circuitry is to prevent circuitry damage if, for example, the positive and negative speaker connection wires are "shorted", or if speaker systems with an impedance less than the indicated rated impedance of this unit are used.

If this occurs, follow the procedure outlined below:

1. Switch OFF the power.
2. Determine the cause of the problem and correct it.
3. Switch ON the power once again.

Note:

When the protection circuitry functions, the unit will not operate unless the power is first switched OFF and then ON again.

■ Accessories

- AC power supply cord
(E), (EG) and (EP) areas : (RJA0019-2K) .. 1
(EB) area : (VJA0733) 1
- Flat cable
Long (REX0661) 1
Medium (REX0660) 1
Short (REX0608) 1
- Remote control transmitter
(RAK-CH144WH) 1
- Batteries
(UM-4, "AAA", R03) 2
Note: These are available on sales route.
- AM (LW/MW) loop antenna
(RSA0012) 1
- Antenna holder
(RMN0244) 1
- Mounting screw
(XTN3+12AFZ) 1
- FM indoor antenna
(RSA0007) 1
- Speaker cords
(REE0499) 2
- Power plug adaptor
for (EB) area only (SJP9009) 1

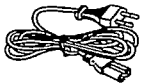

(E), (EG) and (EP)

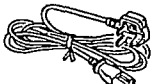

(EB)

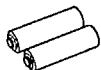
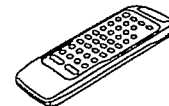

■ Caution for AC Mains Lead



[(EB) area code model only]

For your safety, please read the following text carefully.

This appliance is supplied with a moulded three pin mains plug for your safety and convenience.

A 5-ampere fuse is fitted in this plug.

Should the fuse need to be replaced please ensure that the replacement fuse has a rating of 5-ampere and that it is approved by ASTA or BSI to BS1362.

Check for the ASTA mark  or the BSI mark  on the body of the fuse.

If the plug contains a removable fuse cover you must ensure that it is refitted when the fuse is replaced.

If you lose the fuse cover the plug must not be used until a replacement cover is obtained.

A replacement fuse cover can be purchased from your local dealer.

CAUTION!

IF THE FITTED MOULDED PLUG IS UNSUITABLE FOR THE SOCKET OUTLET IN YOUR HOME THEN THE FUSE SHOULD BE REMOVED AND THE PLUG CUT OFF AND DISPOSED OF SAFELY.

THERE IS A DANGER OF SEVERE ELECTRICAL SHOCK IF THE CUT OFF PLUG IS INSERTED INTO ANY 13-AMPERE SOCKET.

If a new plug is to be fitted please observe the wiring code as shown below.

If in any doubt please consult a qualified electrician.

IMPORTANT

The wires in this mains lead are coloured in accordance with the following code:

Blue: Neutral

Brown: Live

As the colours of the wires in the mains lead of this appliance may not correspond with the coloured markings identifying the terminals in your plug, proceed as follows:

The wire which is coloured BLUE must be connected to the terminal in the plug which is marked with the letter N or coloured BLACK.

This apparatus was produced to BS 800.

The wire which is coloured BROWN must be connected to the terminal in the plug which is marked with the letter L or coloured RED.

Under no circumstances should either of these wires be connected to the earth terminal of the three pin plug, marked with the letter E or the Earth Symbol \perp .

Before use

Remove the connector cover as follows.

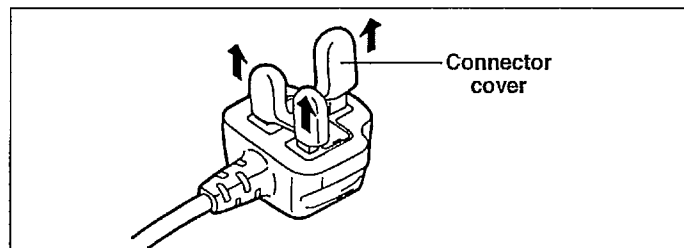

How to replace the fuse

1. Remove the fuse cover with a screwdriver.

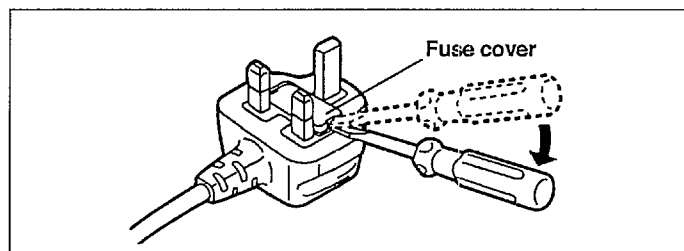

2. Replace the fuse and attach the fuse cover.

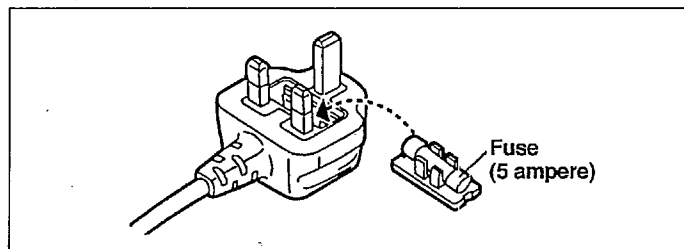

■ Stacking the Components

- Install the various components as shown in the illustration.
- To produce a better stereo sound, install both speakers away from the system.

Horizontal stacking **A**

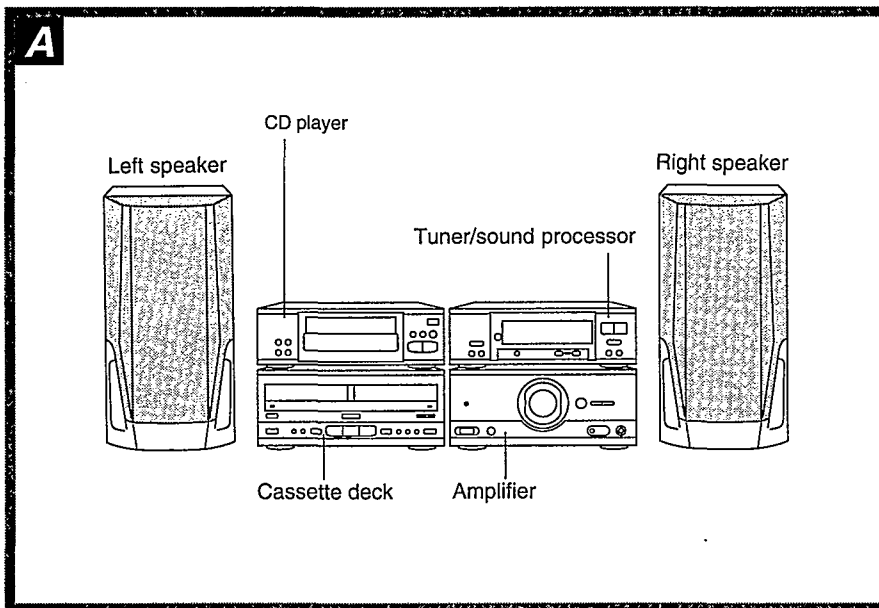

Vertical stacking **B**

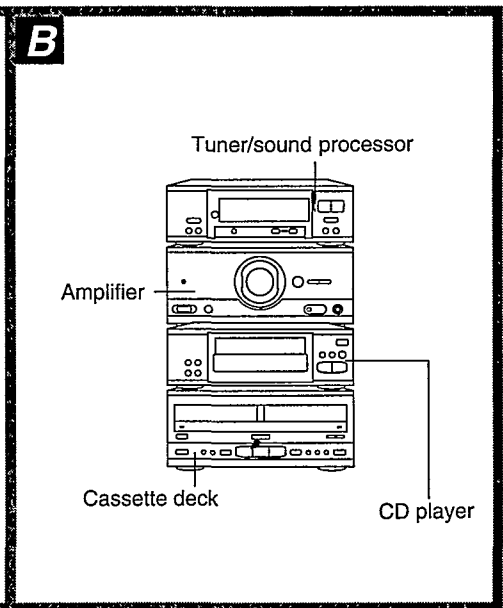

■ Connections

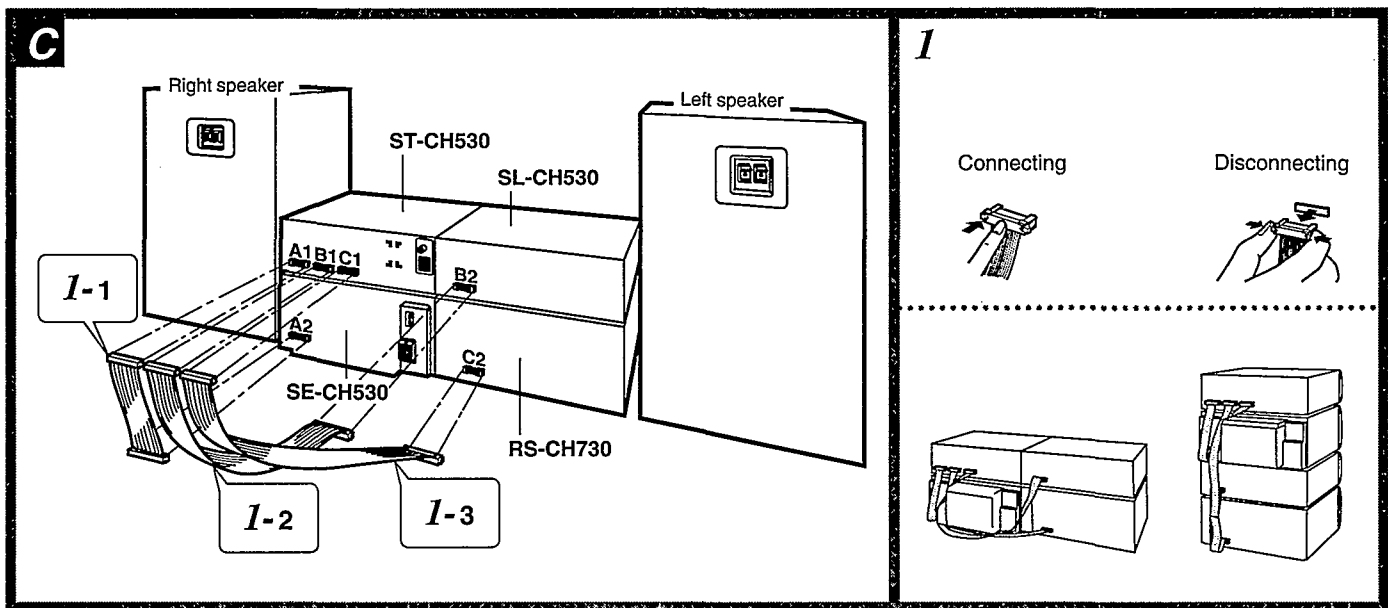

I

Connecting



Disconnecting

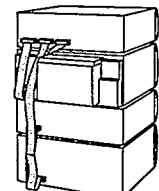
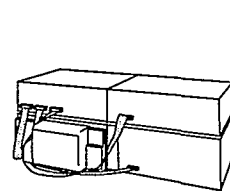

System connections **C**

Connect the AC power supply cord after you have connected all other cables.

I Connect the flat cables.

Hold the connector with the recessed part up and press in at the center until you hear a click.

1. Connect the shorter flat cable to the terminal of the A1 and A2.
2. Connect the longer flat cable to the terminal of the B1 and B2.
3. Connect the longest flat cable to the terminal of the C1 and C2.

To disconnect the flat cable, hold the connector as shown in the illustration, and pull it out.

After connection, fold and press the cable as flat to the back of the unit as possible. (To minimize noise pickup while listening an AM broadcast)

Do not try connecting or disconnecting the flat cables while the power is switched to ON.

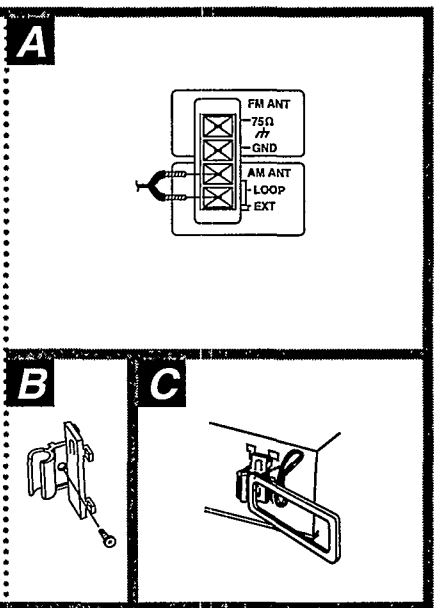
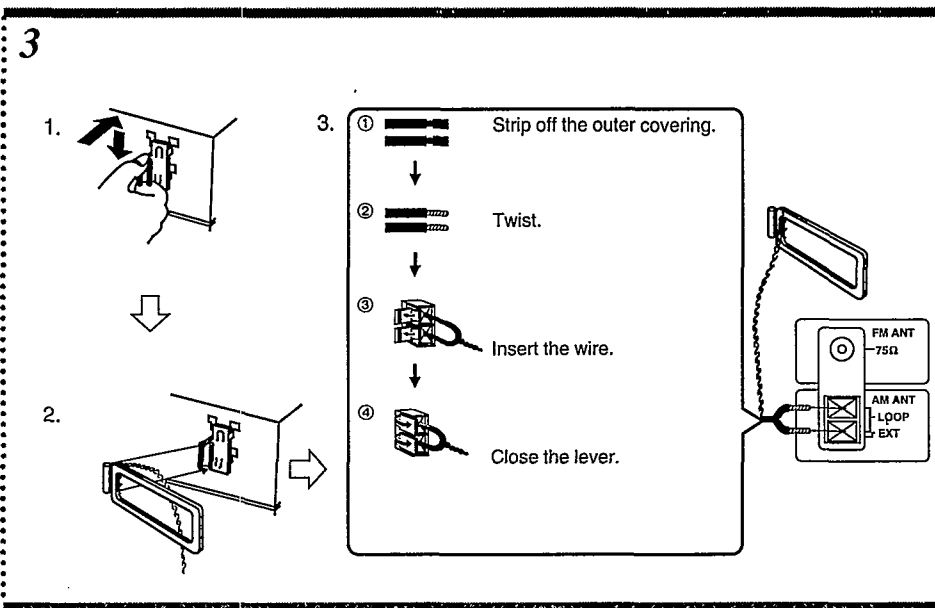
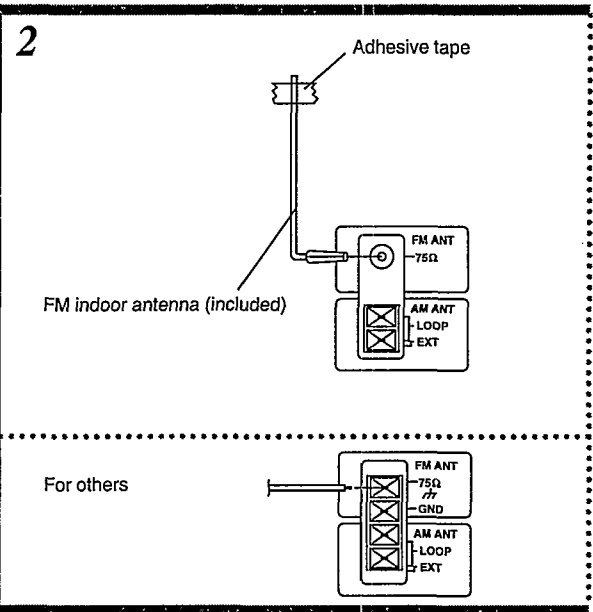
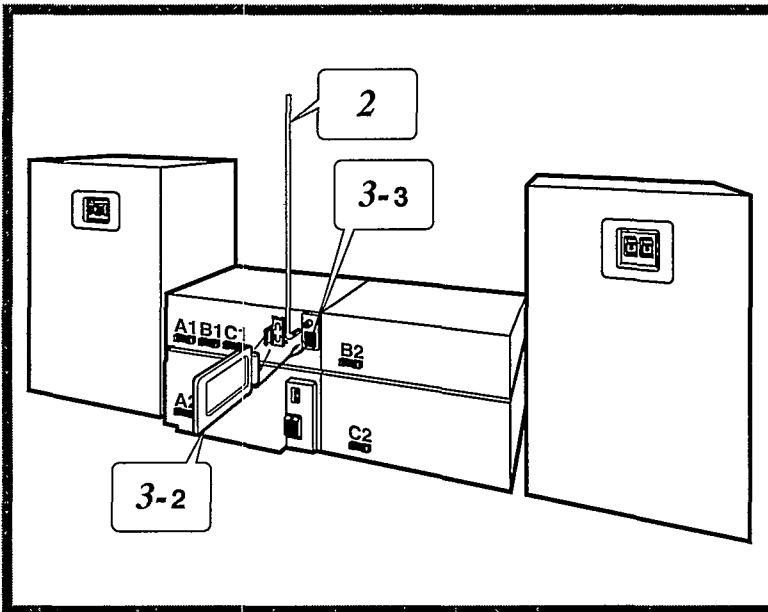

2 Connect the FM indoor antenna.
 The tip of the internal antenna wire should not come into contact with any metal objects.

Note
 When you cannot get a good reception of FM radio broadcast:
 • Install the antenna on a wall at a height and in a direction which result in the best reception.
 • When you cannot get a good reception with this FM indoor antenna, we recommend you install an FM outdoor antenna (not included).

3 Connect the AM (MW/LW) loop antenna.
 1. Attach the antenna holder to the rear panel of the tuner/sound processor. Press the antenna holder hard enough to get it fixed firmly in the place, with a click.
 2. Clamp the antenna with its cord come upward to the antenna holder.
 3. Connect the antenna terminal to the rear panel of the tuner/sound processor.
 • While listening to an MW/LW broadcast, position the loop antenna for the best reception.

For areas except Continental Europe: A
 You may attach the antenna holder to a rack or other structure. Use a screw (included) to attach as shown in the figure. **B**

Note
 To minimize noise pickup, bundle the loop antenna cord using a tape or so to keep the flat cables away from the AM loop antenna cord. **C**

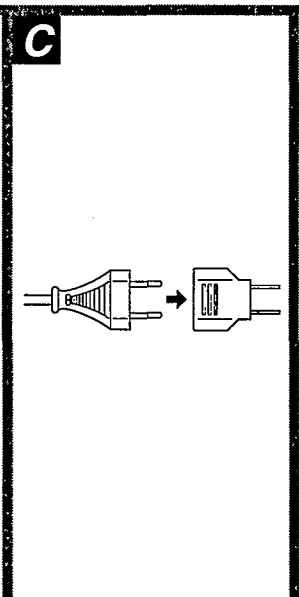
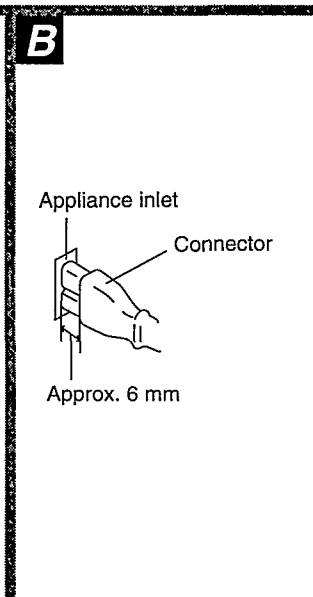
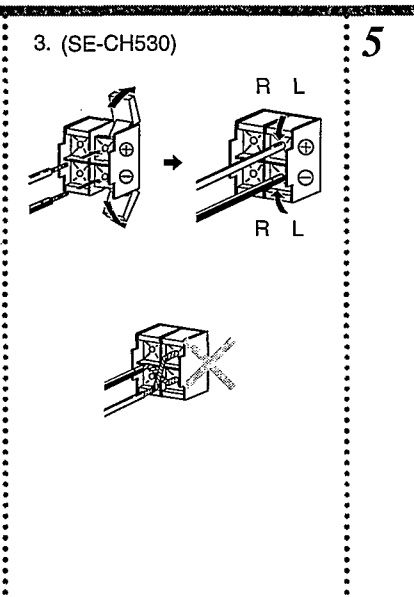
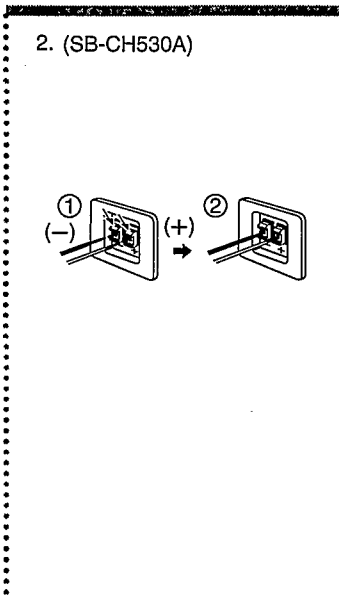
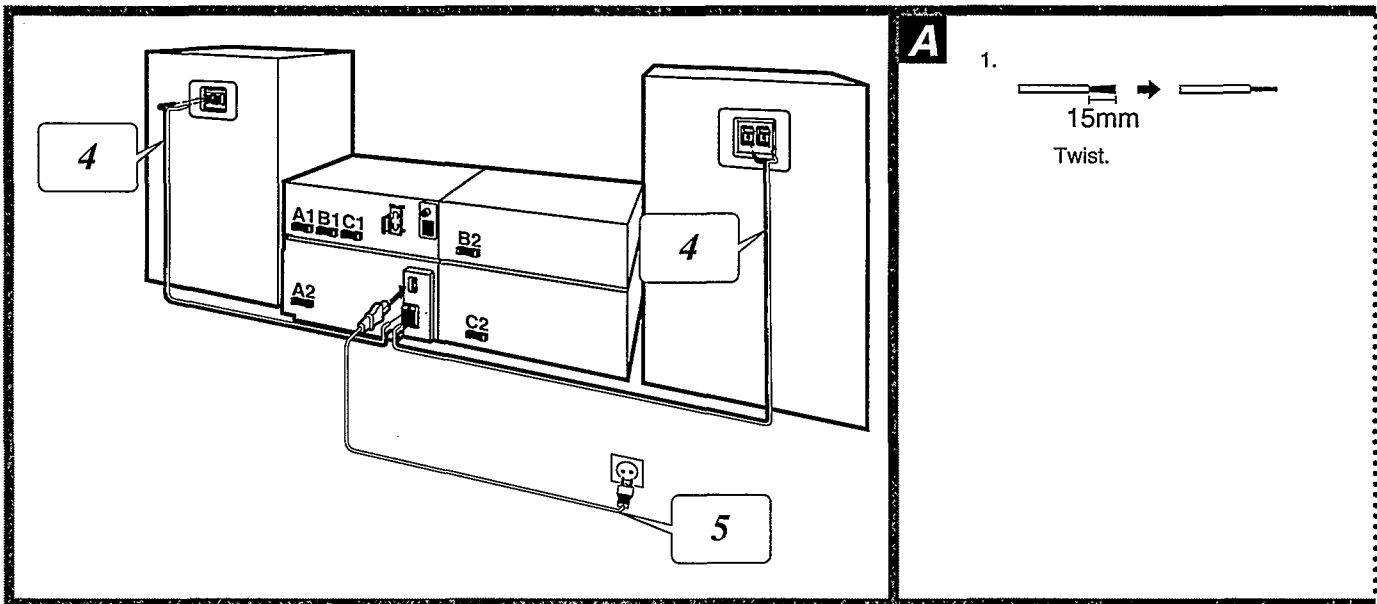

4 Connect the right (R) left and (L) speaker cables.

Notes

- Be sure to connect speaker cables before connecting the AC power supply cord.
- The load impedance of any speaker used with this unit must be 6–8Ω.

Connection of speaker cables **A**

1. Strip off the outer covering, and twist the center conductor. Make sure the bare ends of the wires are not unraveled. (If they are, twist them tight again.)
2. ① Tilt the lever back and insert the wire.
② Close the lever and pull the cord gently to be sure that it is secured.
3. Insert the wire to the rear panel of the amplifier, and close the lever.

Notes

- To prevent damage to circuitry, never short-circuit positive (+) and negative (–) speaker wires.
- Be sure to connect only positive (red) wires to positive (+) terminals and negative (black) wires to negative (–) terminals.

Caution

Use this speaker only with the recommended system.

Failure to do so may lead to damage to the amplifier and/or the speaker, and may result in the risk of fire. Consult a qualified service person if damage has occurred or if you experience a sudden change in performance.

5 Connect the AC power supply cord after you have connected all other cables and cords.

Insertion of Connector **B**

Even when the connector is perfectly inserted, depending on the type of inlet used, the front part of the connector may jut out as shown in the drawing.

However there is no problem using the unit.

For areas except for Continental Europe **C**

If the power plug will not fit your socket, use the power plug adaptor (included).

Optional Antenna Connections

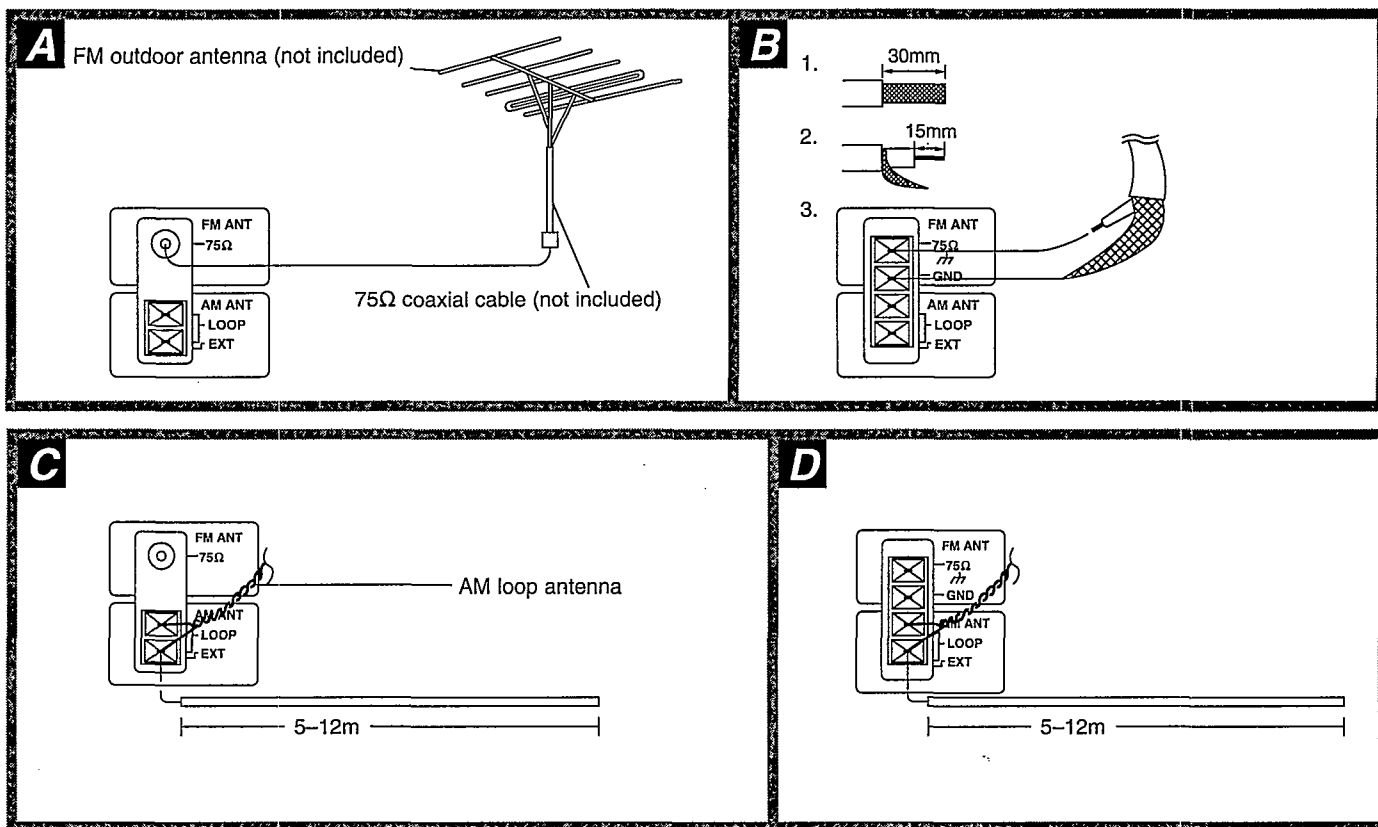

FM outdoor antenna (not included) **A**

You may need an outdoor antenna if you use this system in a mountainous region or inside a reinforced-concrete building, etc. An outdoor antenna should be installed by a competent technician only.

For areas except Continental Europe: **B**

1. Remove a piece of the outer vinyl sheath from the end.
2. Bundle the shield braid, and remove a piece of the inner vinyl sheath covering the core wire.
3. Connect the core wire and the shield braid.

AM (MW/LW) outdoor antenna (not included) **C**

An outdoor antenna may be required in a mountainous region, or if this system is located inside a reinforced-concrete building, etc.

Connect the outdoor antenna without removing the AM loop antenna.

Run 5 to 12 m of vinyl-covered wire horizontally along a window or other convenient location.

For areas except Continental Europe: **D**

External Unit Connection

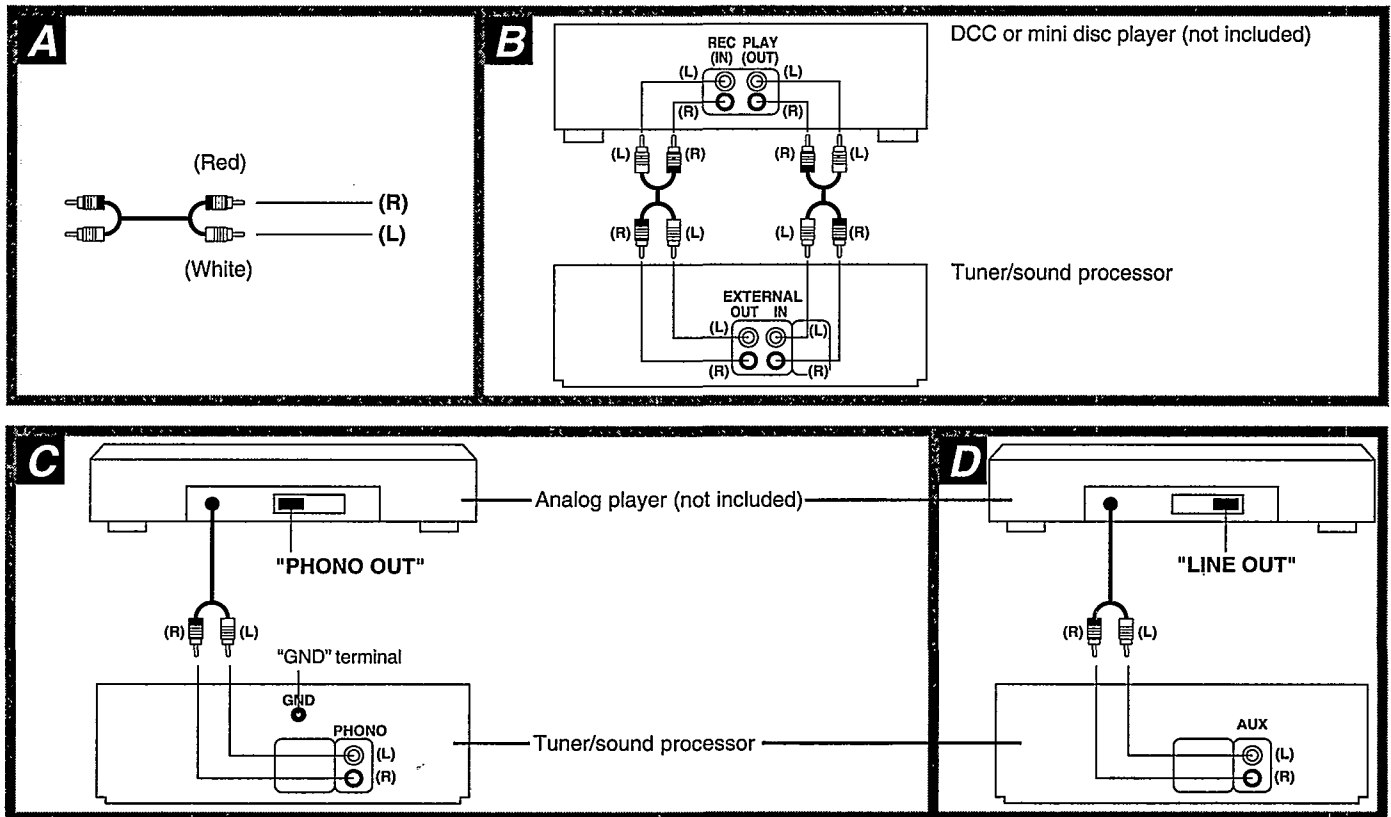

- For details, refer to the operating instructions of the units which are to be connected.
- When units other than those described below are to be connected, please consult with your audio dealer.

Connecting the stereo connection cable (not included) **A**

Connect the red plug to the right (R) connector.
Connect the white plug to the left (L) connector.

DCC (digital compact cassette deck) or mini disc player **B**

Analog player

This example shows how to connect the analog player with the PHONO OUT/LINE OUT switch.

For Continental Europe: **C**

"GND" terminal is for a ground wire use.

Set to the PHONO OUT position at the back of the analog player.

For others: **D**

Only an analog player with a built-in phono equalizer can be connected.

Set to the LINE OUT position at the back of the analog player.

Location of Controls

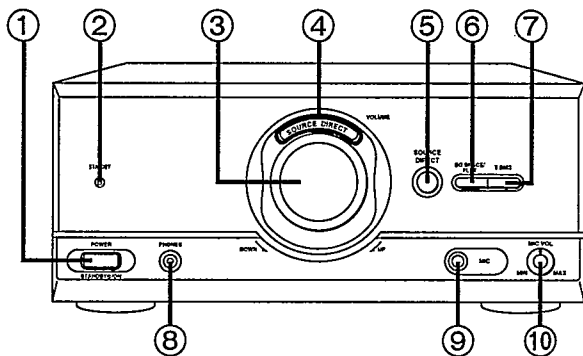

① Power "STANDBY" switch (POWER, STANDBY)

Press to switch the unit from on to standby mode or vice versa. In standby mode, the unit is still consuming a small amount of power.

② Standby indicator (STANDBY)

When the unit is connected to the AC mains supply, this indicator lights up in standby mode and goes out when the unit is turned on.

③ Volume control (VOLUME)

④ Source direct indicator (SOURCE DIRECT)

⑤ Source direct button (SOURCE DIRECT)

⑥ EQ SPACE/flat button (EQ SPACE/FLAT)

⑦ V. bass button (V. BASS)

⑧ Headphones jack (PHONES) (ϕ 3.5, 32 Ω)

⑨ Microphone jack (MIC) (ϕ 6.3, 600 Ω)

⑩ Microphone volume control (MIC VOL)

■ Operation Check and Main Component Replacement Procedures

NOTE

1. This section describes procedures for checking the operation of the major printed circuit boards and replacing the main components.
2. For reassembly after operation checks or replacement, reverse the respective procedures. Special reassembly procedures are described only when required.
3. Select items from the following index when checks or replacement are required.
4. Illustrated screws are equivalent to actual size.
5. Refer the parts No. on the page of "Main Component Replacement Procedures", if necessary.

● Contents

• Checking Procedures for each P.C.B.	Page.
1. Checking for the operation P.C.B..	9.
2. Checking for the main P.C.B..	10.
• Main Component Replacement Procedures	
1. Replacement for the power IC and regulator transistor.	10.

■ Checking Procedure for each P.C.B.

1. Checking for the operation P.C.B.

Step 2
b

Step 3
Remove the cabinet.

Step 1
a × 4

Step 5
Pull out the front panel ass'y.

Step 4
c × 2

• Check the operation P.C.B. as shown below.

Operation P.C.B.





a
[RHD30007-K1] (Black)

b
[XTBS3+10JFZ1] (Black)

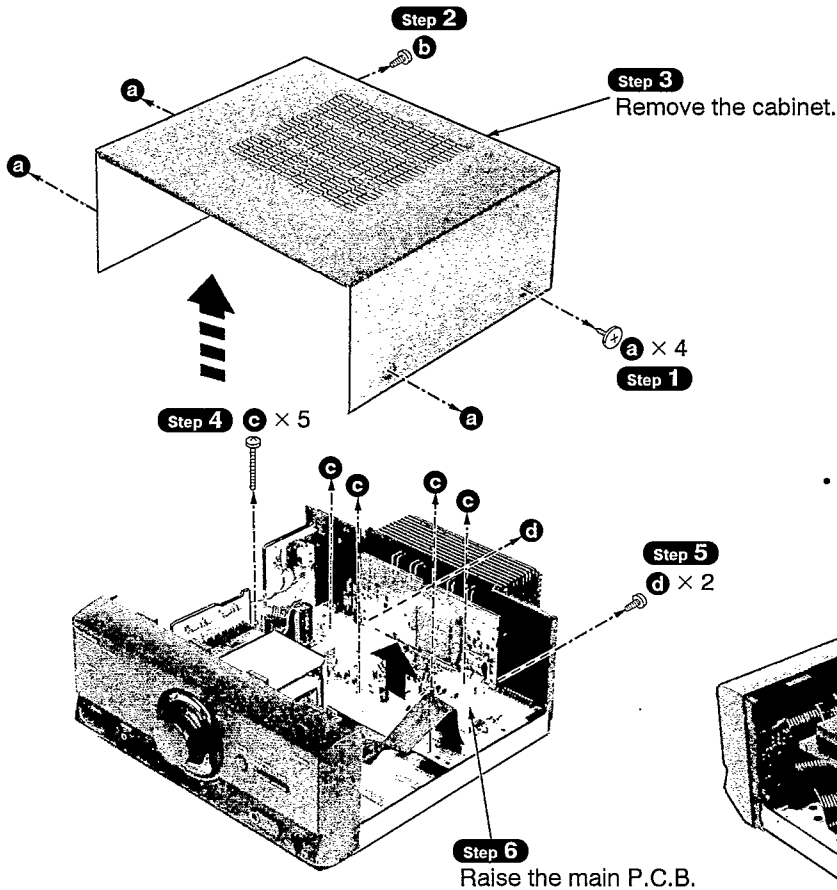
c
[XTBS3+8JFZ1] (Black)

2. Checking for the main P.C.B.

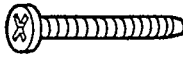

-  a
[RHD30007-K1] (Black)
-  b
[XTBS3+10JFZ1] (Black)
-  c
[XTB3+20JFZ] (Black)
-  d
[XTB3+10JFZ] (Black)

• Check the main P.C.B. as shown below.

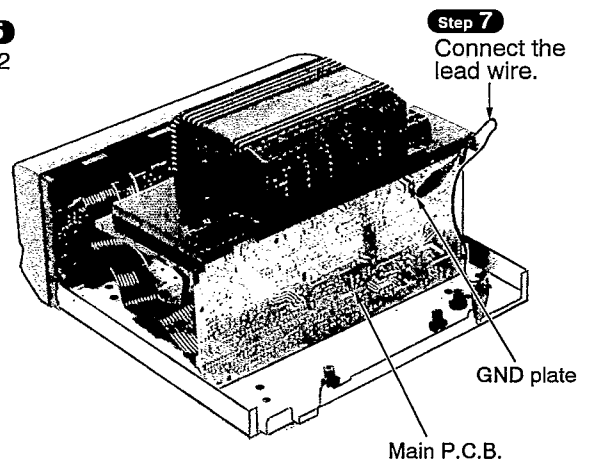

■ Main Component Replacement Procedures

1. Replacement for the power IC and regulator transistor

NOTE

When mounting the power IC or regulator transistor, apply silicone compound (RFKX0002) to the rear side of power IC or regulator transistors.

• Follow the item 2 (Step 1 ~ Step 6) checking procedures for each P.C.B..

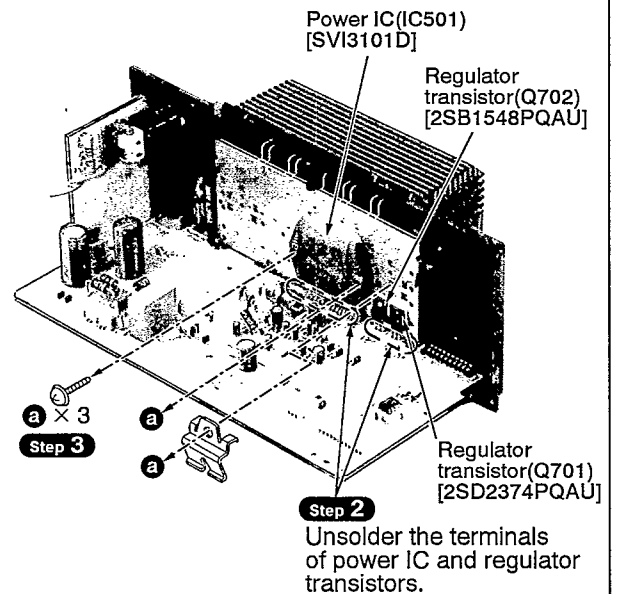
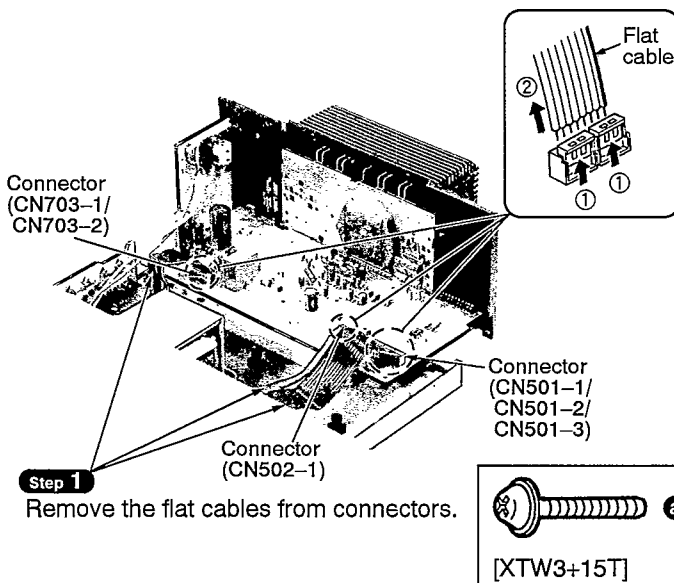

■ Power Source ON/OFF of This Unit

1. Connect the AC power cord of this unit to an AC outlet and turn it on.
(This unit comes to stand-by mode.)
2. Make test point **TP701** short as shown in Fig. 1.
POWER indicator lights and this unit comes to power ON mode.

Operation Check

1. Set this unit to power ON mode.
2. Input a signal (1 kHz, 100 mV) to the section between the jumper **J603** (LINE IN for L-ch) and the jumper **J308** (LINE IN GND) as well as the section between the jumper **J604** (LINE IN R-ch) and the jumper **J308**.
3. Connect the speaker to the speaker terminals and check if it sounds from the speaker.

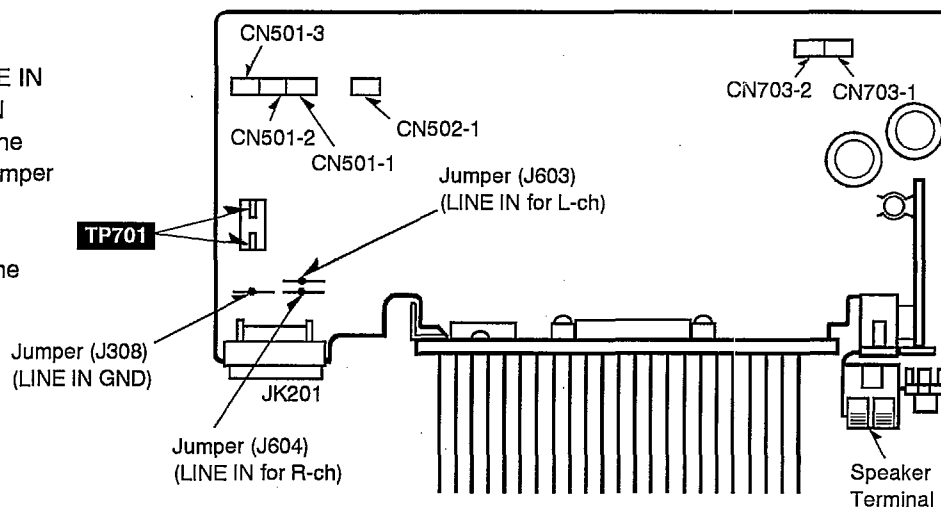

Fig. 1

■ Schematic Diagram

Page

A OPERATION CIRCUIT	12
B MAIN CIRCUIT	12, 13
C POWER TRANSFORMER CIRCUIT	13
D AC IN TERMINAL CIRCUIT	13

- This schematic diagram may be modified at any time with the development of new technology.

Notes:

- **S601** : Power "STANDBY ϕ /ON" switch (POWER STANDBY ϕ /ON)
- **S606** : SOURCE DIRECT switch
- **S607** : EQ SPACE/FLAT switch
- **S608** : V. BASS switch
- **VR401** : Microphone volume control (MIC VOLUME)
- **VR601** : Volume control (VOL)

- Indicated voltage values are the standard values for the unit measured by the DC electronic circuit tester (high-impedance) with the chassis taken as standard. Therefore, there may exist some errors in the voltage values, depending on the internal impedance of the DC circuit tester.
No mark: Power ON

Important safety notice:

Components identified by \triangle mark have special characteristics important for safety.

Furthermore, special parts which have purposes of fire-retardant (resistors), high-quality sound (capacitors), low-noise (resistors), etc. are used. When replacing any of components, be sure to use only manufacturer's specified parts shown in the parts list.

Caution!

IC and LSI are sensitive to static electricity.

Secondary trouble can be prevented by taking care during repair.

Cover the parts boxes made of plastics with aluminum foil.

Ground the soldering iron.

Put a conductive mat on the work table.

Do not touch the legs of IC or LSI with the fingers directly.

Voltage and signal line

- : Positive voltage line
- ←←←← : Negative voltage line
- : Source signal Line (L-ch)
- : Mic signal

A OPERATION CIRCUIT (P.C.Board: on page 15)

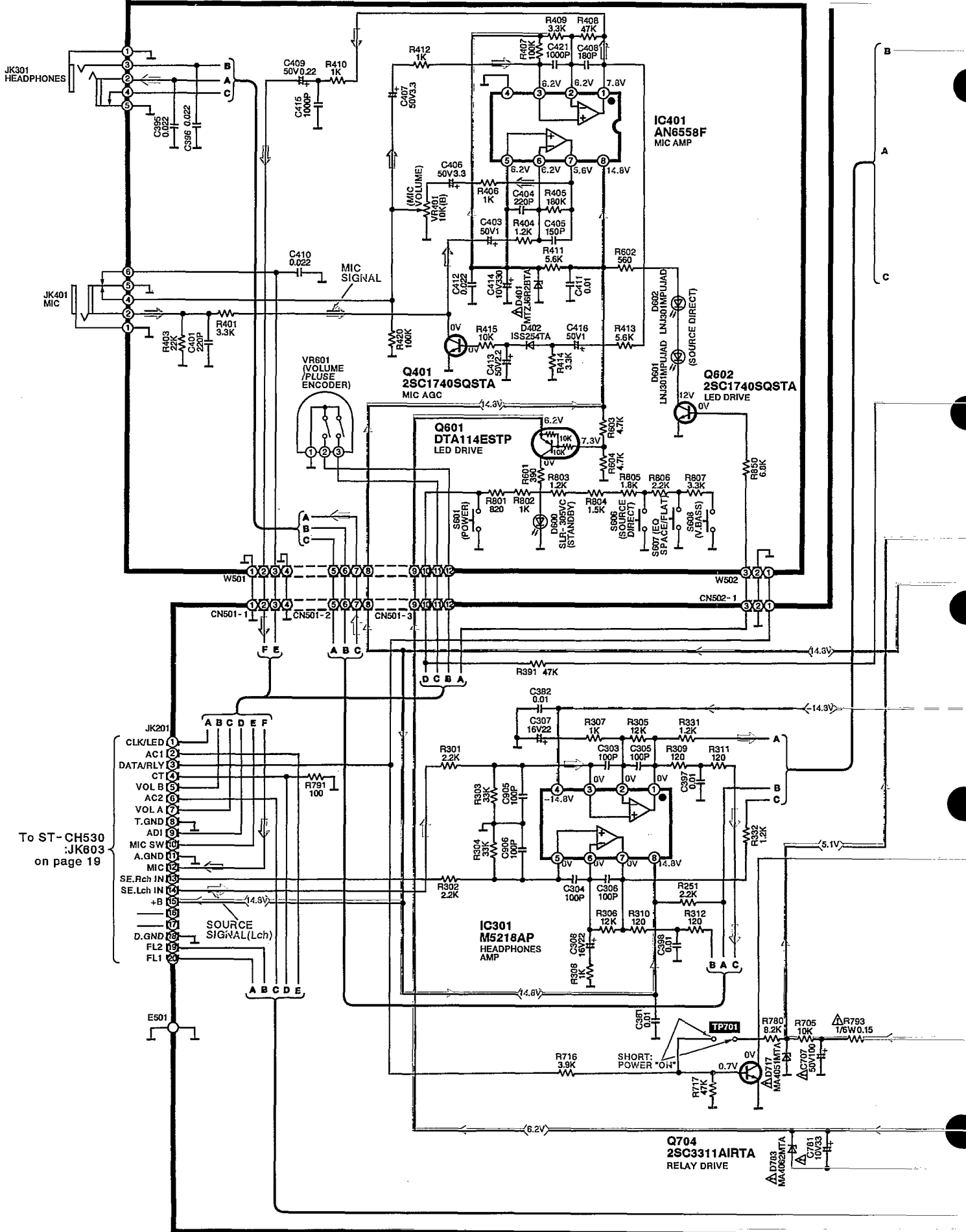

To ST-CH530 :JK803 on page 19

→ : Source signal Line (L-ch) → : Mic signal

B MAIN CIRCUIT (P.C.Board: on page14)

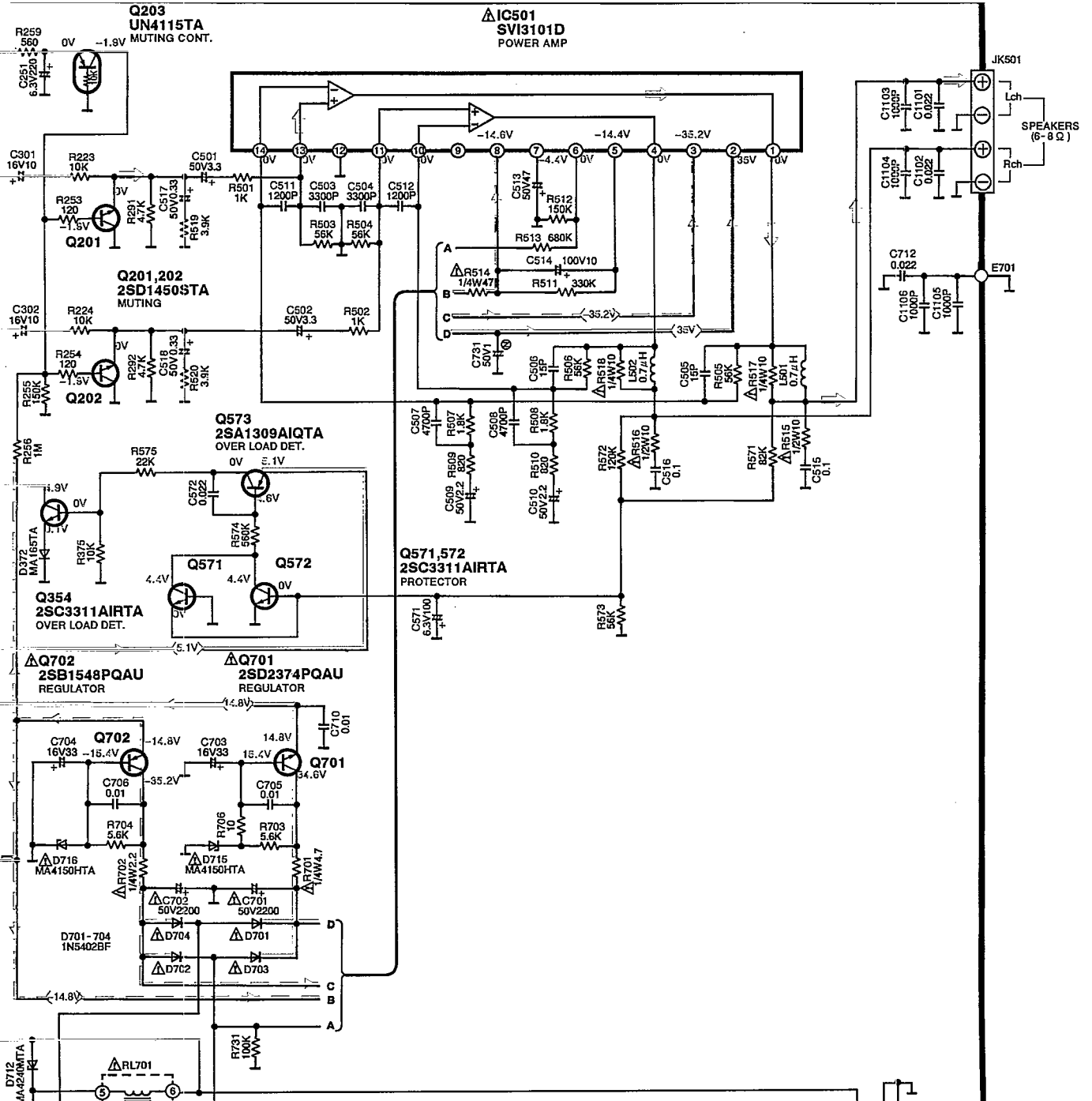

C POWER TRANSFORMER CIRCUIT (P.C.Board: on page15)

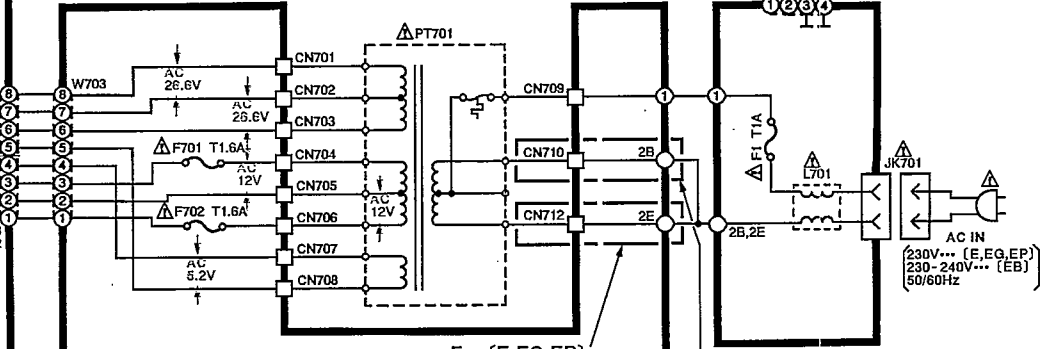

D AC IN TERMINAL CIRCUIT (P.C.Board: on page15)

Printed Circuit Board Diagram

• This circuit board diagram may be modified at any time with the development of new technology.

B MAIN P.C.B. (REP2107A-M)

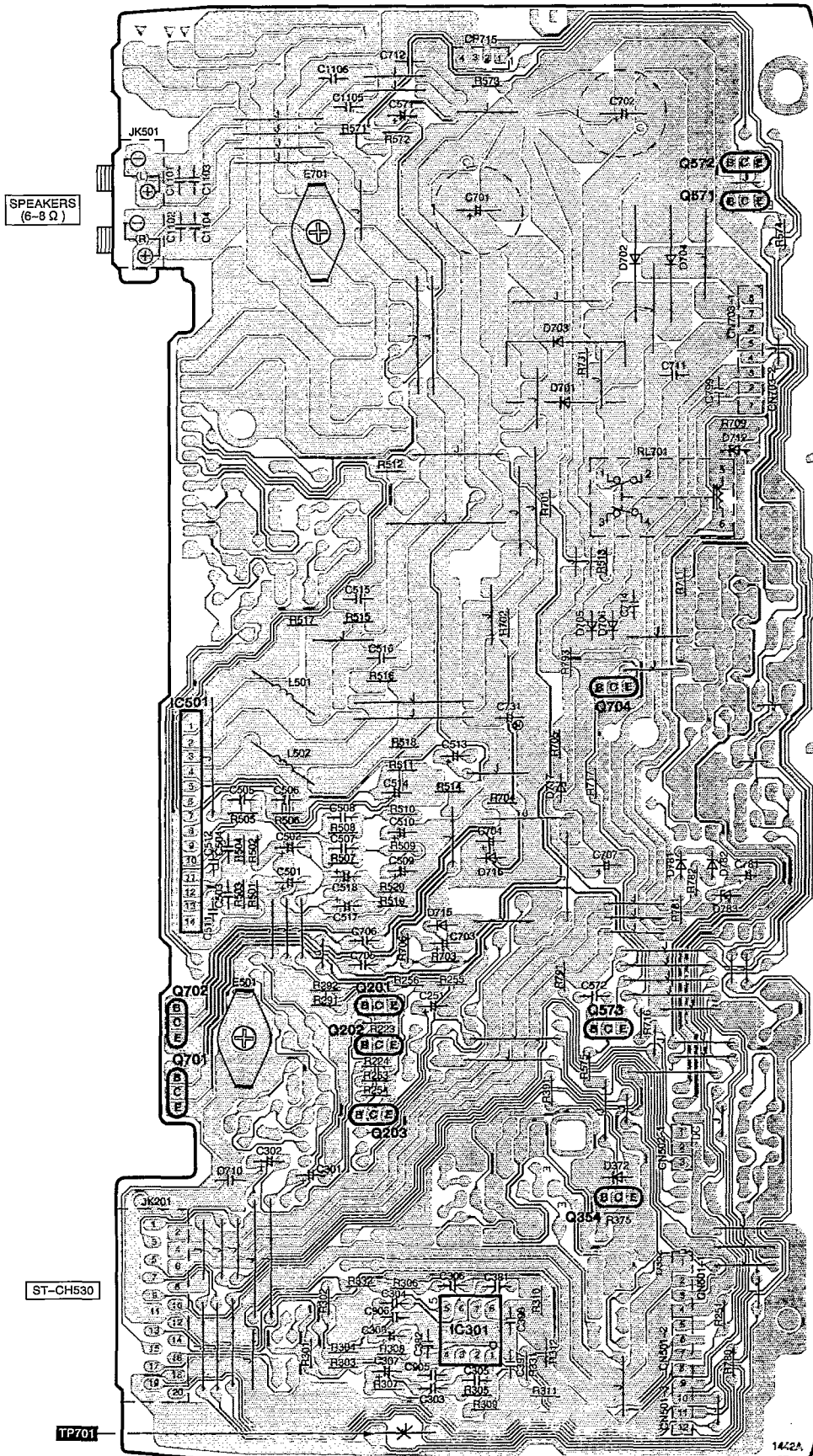

A OPERATION P.C.B.
(REP2108A-S)

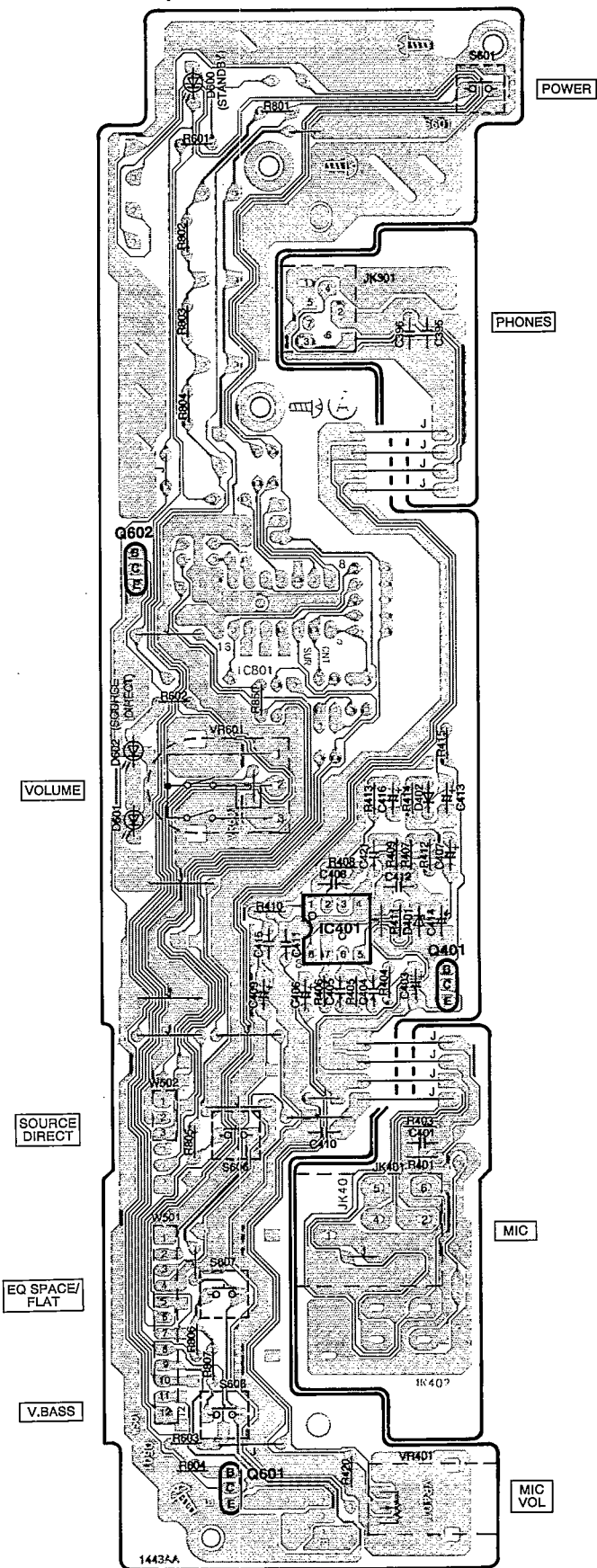

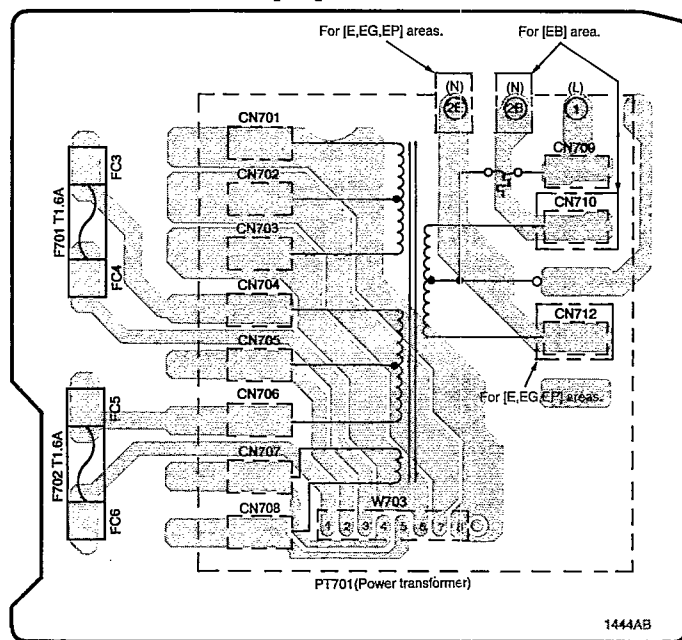

C POWER TRANSFORMER P.C.B.
(REP2109A-P...[E,EG,EP]
REP2109B-P...[EB])

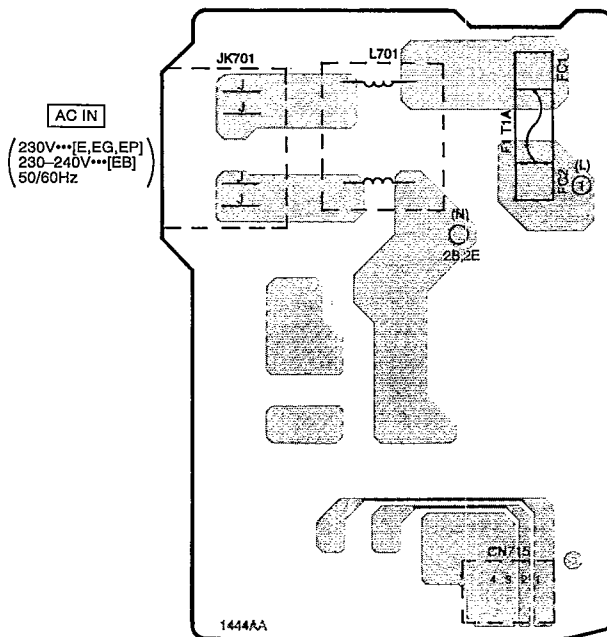

D AC IN TERMINAL P.C.B. (REP2109A-P...[E,EG,EP]
REP2109B-P...[EB])

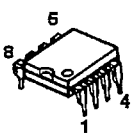
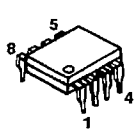
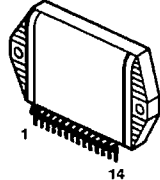
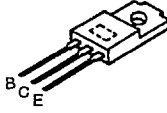

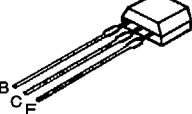
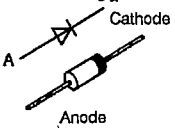
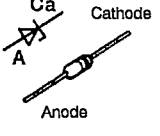
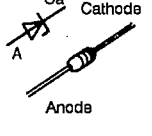
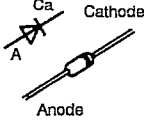
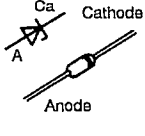
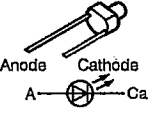
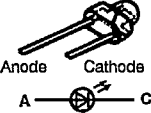
<p>AN6558F</p> 	<p>M5218AP</p> 	<p>SVI3101D</p> 	<p>2SB1548PQAU 2SD2374PQAU</p> 	<p>UN4115 2SA1309AIQTA 2SC3311AIRTA 2SD1450RTA</p> 	
<p>2SC1740SQ DTA114ESTP</p> 	<p>1N5402BF RL1N4003N02</p> 	<p>MA4150M MA4240H</p> 	<p>MA4051MTA MA4062MTA</p> 	<p>MA165 1SS254TA</p> 	<p>MTZJ6R2BTA</p> 
<p>SLR-305VC</p> 	<p>LNJ301MPUJAD</p> 				

■ Wiring Connection Diagram

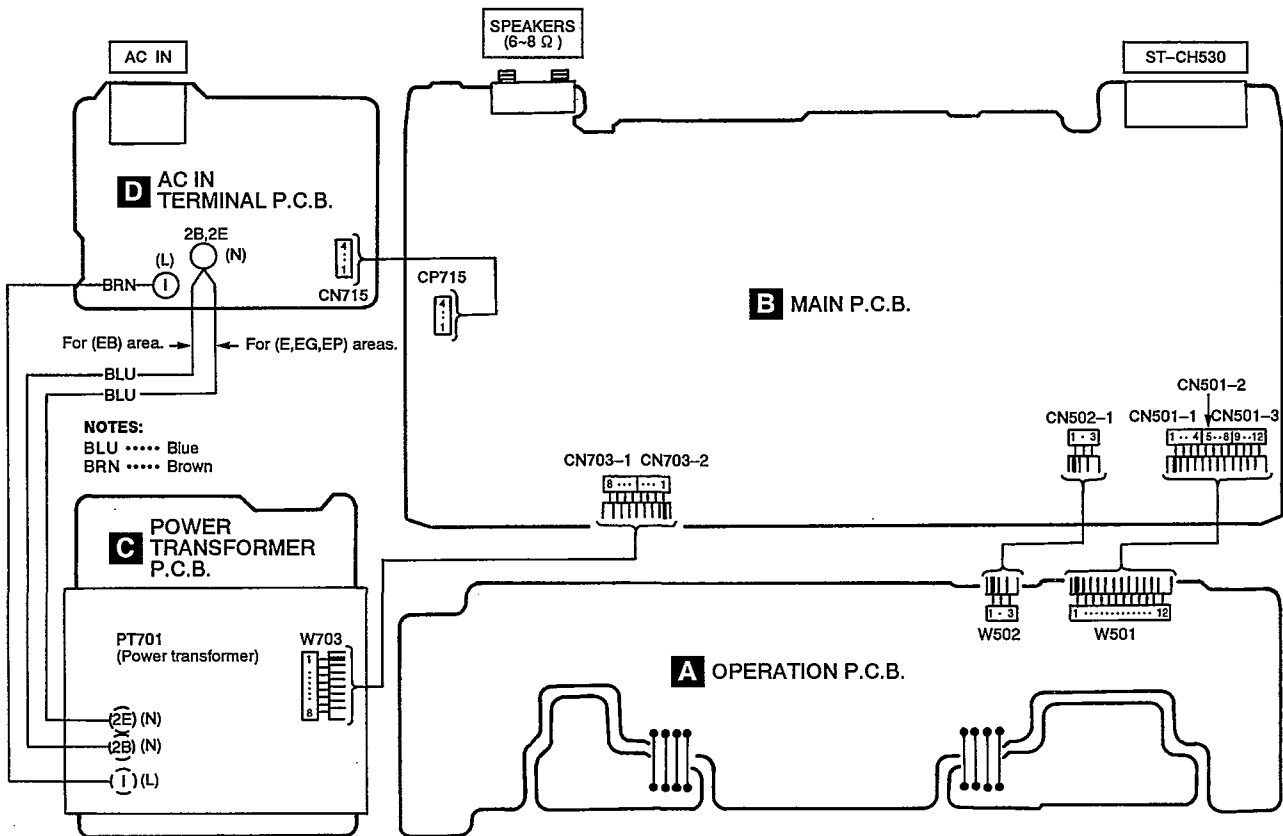

Block Diagram

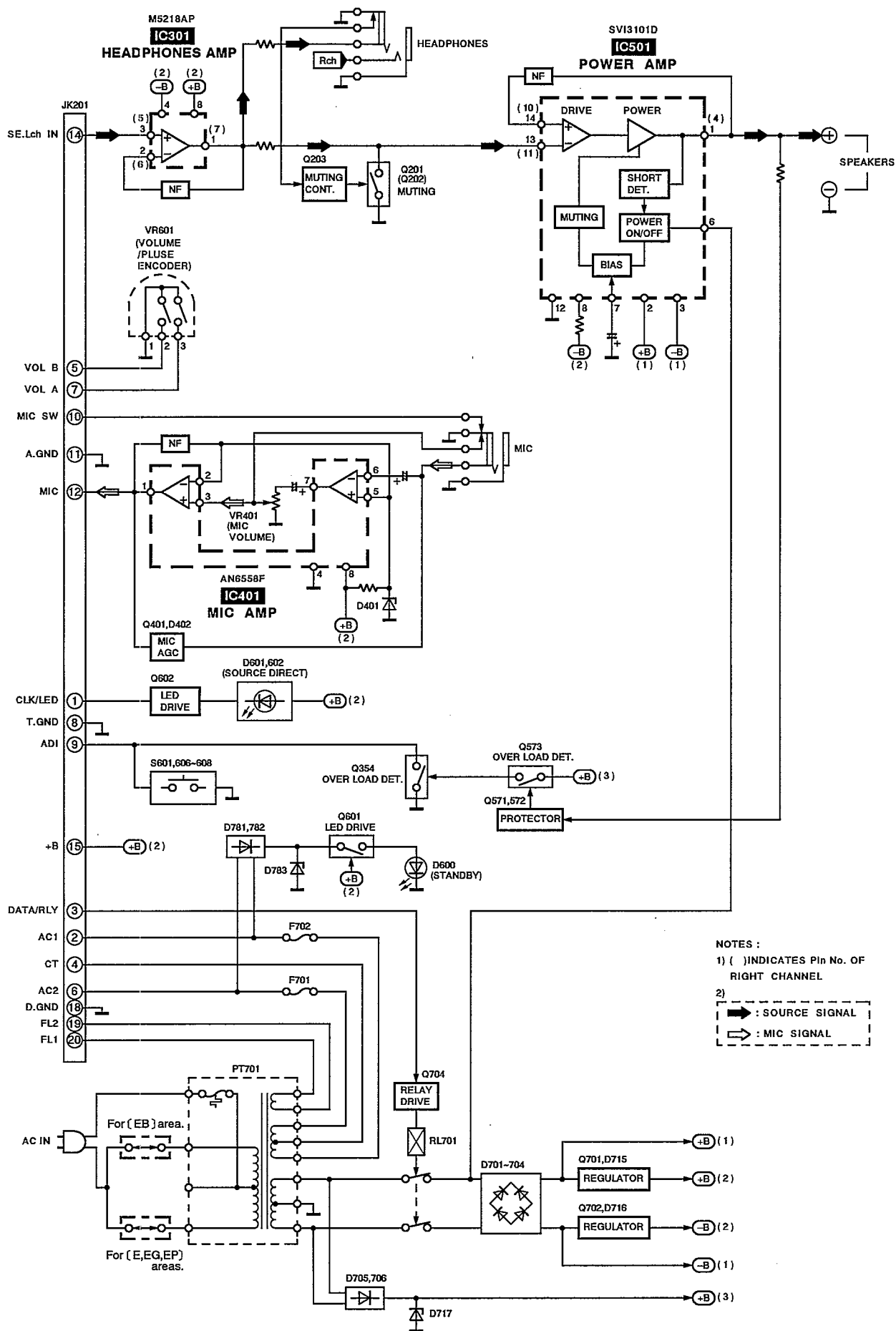

NOTES :
 1) () INDICATES Pin No. OF RIGHT CHANNEL
 2)
 — : SOURCE SIGNAL
 ⇨ : MIC SIGNAL

Replacement Parts List

Notes: *Important safety notice:

 Components identified by Δ mark have special characteristics important for safety.

Furthermore, special parts which have purposes of fire-retardant (resistors), high-quality sound (capacitors), low-noise (resistors), etc. are used.

When replacing any of components, be sure to use only manufacture's specified parts shown in the parts list.

*The parenthesized indications in the Remarks columns specify the areas. (Refer to the cover page for area.)

Parts without these indications can be used for all areas.

*Remote Control Ass'y: Supply period for three years from termination of production.

*The "(SF)" mark denotes the standard part.

*<VRD>: indicates parts that are supplied by Video Recorder Division.

Ref. No.	Part No.	Part Name & Description	Remarks	Ref. No.	Part No.	Part Name & Description	Remarks
		INTEGRATED CIRCUIT(S)		S601	EVQ21405R	SW, POWER	
IC301	M5218AP	IC, HEADPHONE AMP.		S606	EVQ21405R	SW, SOURCE DIRECT	
IC401	AN6558F	IC, MIC AMP.		S607	EVQ21405R	SW, EQ SPACE/FLAT	
IC501	SVI3101D	IC, POWER AMP.	Δ	S608	EVQ21405R	SW, V. BASS	
		TRANSISTOR(S)				CONNECTOR(S)	
Q201, 202	2SD1450RTA	TRANSISTOR		CN701-709	RJSIA1101T1	CONNECTOR(1P)	
Q203	UN4115	TRANSISTOR		CN710	RJSIA1101T1	CONNECTOR(1P)	(EB)
Q354	2SC3311AIRTA	TRANSISTOR		CN712	RJSIA1101T1	CONNECTOR(1P)	(E, EG, EP)
Q401	2SC1740SQ	TRANSISTOR		CN715	RJU057W004	SOCKET(4P)	
Q571, 572	2SC3311AIRTA	TRANSISTOR		CN501-1-3	RJSIA6604	CONNECTOR(4P)	
Q573	2SA1309AIQTA	TRANSISTOR		CN502-1	RJSIA6603	CONNECTOR(3P)	
Q601	DTA114ESTP	TRANSISTOR		CN703-1, 2	RJSIA6604	CONNECTOR(4P)	
Q602	2SC1740SQ	TRANSISTOR		CP715	RJT057W004-1	CONNECTOR(4P)	
Q701	2SD2374PQAU	TRANSISTOR	Δ			EARTH TERMINAL(S)	
Q702	2SB1548PQAU	TRANSISTOR	Δ	E501	SNE1004-2	GND PLATE	
Q704	2SC3311AIRTA	TRANSISTOR		E701	SNE1004-2	GND PLATE	
		DIODE(S)				FUSE HOLDER(S)	
D372	MA165	DIODE		FC1-6	EYF52BC	FUSE HOLDER	
D401	MTZJ6R2BTA	DIODE	Δ			TRANSFORMER(S)	
D402	1SS254TA	DIODE		PT701 Δ	RTP2M5B007	POWER TRANSFORMER	
D600	SLR-305VC	LED				RELAY	
D601, 602	LNJ301MPUJAD	DIODE		RL701 Δ	RSY0013M-0	RELAY	
D701-704	1N5402BF	DIODE	Δ			JACK(S)	
D705, 706	RL1N4003N02	DIODE	Δ	JR201	RJT065K20	CONNECTOR(20P)	
D712	MA4240H	DIODE		JK301	RJJ37TN01-C	HEADPHONES JACK	
D715, 716	MA4150M	DIODE	Δ	JK401	RJJ65MA01	MIC JACK	
D717	MA4051MTA	DIODE	Δ	JK501	RJR0054M	SPEAKER TERMINAL	
D781, 782	MA165	DIODE	Δ	JK701	SJS9236	AC INLET	Δ
D783	MA4062MTA	DIODE	Δ				
		VARIABLE RESISTOR(S)					
VR401	EVJ02BF02B14	V. R, MIC VOLUME CONTROL					
VR601	EVQHWVF2024B	V. R, MAIN VOLUME CONTROL					
		COIL(S)					
L501, 502	RLQYR73M	COIL					
L701	RLQZ271M	COIL	Δ				
		FUSE(S)					
F1	XBA2C10TBO	FUSE, 250V T1A	Δ				
F701, 702	XBA2C16TBO	FUSE, 250V T1.6A	Δ				
		SWITCH(ES)					

Notes : * Capacity values are in microfarads (μF) unless specified otherwise, P=Pico-farads (pF) F=Farads (F)
 * Resistance values are in ohms, unless specified otherwise, 1K=1,000 (OHM) , 1M=1,000k(OHM)

Ref. No.	Part No.	Values & Remarks	Ref. No.	Part No.	Values & Remarks	Ref. No.	Part No.	Values & Remarks
		RESISTORS	R601	ERDS2TJ391	1/4W 390	C421	ECBT1H102KB5	50V 1000P
R223, 224	ERDS2TJ103	1/4W 10K	R602	ERDS2TJ561	1/4W 560	C501, 502	ECA1HAP3R3B	50V 3.3U
R251	ERDS2TJ222	1/4W 2.2K	R603, 604	ERDS2TJ472	1/4W 4.7K	C503, 504	ECBT1C332KR5	16V 3300P
R253, 254	ERDS2EJ121	1/4W 120	R701 Δ	ERD2FCVJ4R7T	1/4W 4.7	C505, 506	ECBT1H150J5	50V 15P
R255	ERDS2TJ154	1/4W 150K	R702 Δ	ERD25FJ2R2	1/4W 2.2	C507, 508	ECBT1C472KR5	16V 4700P
R256	ERDS2TJ105T	1/4W 1M	R703, 704	ERDS2TJ562	1/4W 5.6K	C509, 510	ECEA1HKA2R2B	50V 2.2U
R259	ERDS2TJ561	1/4W 560	R705	ERDS2TJ103	1/4W 10K	C511, 512	ECBT1C122KR5	16V 1200P
R291, 292	ERDS2TJ472	1/4W 4.7K	R706	ERDS2TJ100	1/4W 10	C513	ECA1HM470B	50V 47U
R301, 302	ERDS2TJ222	1/4W 2.2K	R709	ERGSJ221E	1W 220	C514	ECA2AAP100B	100V 10U
R303, 304	ERDS2TJ333	1/4W 33K	R711	ERGSJ271E	1W 270	C515, 516	ECFR1H104ZF	50V 0.1U
R305, 306	ERDS2TJ123	1/4W 12K	R716	ERDS2TJ392T	1/4W 3.9K	C517, 518	ECEA1HKAR33B	50V 0.33U
R307, 308	ERDS2TJ102	1/4W 1K	R717	ERDS2TJ473	1/4W 47K	C571	RCE0JKA101BV	6.3V 100U
R309-312	ERDS2EJ121	1/4W 120	R731	ERDS2TJ104	1/4W 100K	C572	ECBT1E223ZF	25V 0.022U
R331, 332	ERDS2TJ122	1/4W 1.2K	R780	ERDS2TJ822	1/4W 8.2K	C701, 702 Δ	ECA1HM222B	50V 2200U
R375	ERDS2TJ103	1/4W 10K	R781, 782	ERDS2TJ561	1/4W 560	C703, 704	ECEA1CKA330B	16V 33U
R391	ERDS2TJ473	1/4W 47K	R791	ERDS2TJ101	1/4W 100	C705, 706	ECKR1H103ZF5	50V 0.01U
R401	ERDS2TJ332	1/4W 3.3K	R793 Δ	ERQ16NKWR15E	1/6W 0.15	C707 Δ	ECA1HM101B	50V 100U
R403	ERDS2TJ223	1/4W 22K	R801	ERDS2TJ821	1/4W 820	C710	ECBT1E103ZF	25V 0.01U
R404	ERDS2TJ122	1/4W 1.2K	R802	ERDS2TJ102	1/4W 1K	C711	ECQE1104KF3	100V 0.1U
R405	ERDS2TJ184T	1/4W 180K	R803	ERDS2TJ122	1/4W 1.2K	C712	ECBT1E223ZF	25V 0.022U
R406	ERDS2TJ102	1/4W 1K	R804	ERDS2TJ152	1/4W 1.5K	C714	ECKR1H103ZF5	50V 0.01U
R407	ERDS2TJ104	1/4W 100K	R805	ERDS2TJ182	1/4W 1.8K	C731	ECEA1HKN010B	50V 1U
R408	ERDS2TJ473	1/4W 47K	R806	ERDS2TJ222	1/4W 2.2K	C781 Δ	RCE1AKA330BG	10V 33U
R409	ERDS2TJ332	1/4W 3.3K	R807	ERDS2TJ332	1/4W 3.3K	C799	ECBT1H104ZF5	50V 0.1U
R410	ERDS2TJ102	1/4W 1K	R850	ERDS2TJ682T	1/4W 6.8K	C905, 906	ECBT1H101KB5	50V 100P
R411	ERDS2TJ562	1/4W 5.6K			CAPACITORS	C1101, 1102	ECBT1E223ZF	25V 0.022U
R412	ERDS2TJ102	1/4W 1K	C251	RCE0JKA221BV	6.3V 220U	C1103-1106	ECBT1H102KB5	50V 1000P
R413	ERDS2TJ562	1/4W 5.6K	C301, 302	RCE1CKA100BG	16V 10U			
R414	ERDS2TJ332	1/4W 3.3K	C303-306	ECBT1H101KB5	50V 100P			
R415	ERDS2TJ103	1/4W 10K	C307, 308	RCE1CKA220BG	16V 22U			
R420	ERDS2TJ104	1/4W 100K	C381, 382	ECBT1E103ZF	25V 0.01U			
R501, 502	ERDS2TJ102	1/4W 1K	C395, 396	ECBT1E223ZF	25V 0.022U			
R503-506	ERDS2TJ563	1/4W 56K	C397, 398	ECBT1E103ZF	25V 0.01U			
R507, 508	ERDS2TJ182	1/4W 1.8K	C401	ECBT1H221KB5	50V 220P			
R509, 510	ERDS2TJ821	1/4W 820	C403	ECEA1HKA010B	50V 1U			
R511	ERDS2TJ334	1/4W 330K	C404	ECBT1H221KB5	50V 220P			
R512	ERDS2TJ154	1/4W 150K	C405	ECBT1H151KB5	50V 150P			
R513	ERDS2TJ684	1/4W 680K	C406, 407	ECEA1HKA3R3B	50V 3.3U			
R514 Δ	ERD25FJ470	1/4W 47	C408	ECBT1H181KB5	50V 180P			
R515, 516 Δ	ERDS1FVJ100T	1/2W 10	C409	ECEA1HKAR22B	50V 0.22U			
R517, 518 Δ	ERD25FVJ100T	1/4W 10	C410	ECBT1E223ZF	25V 0.022U			
R519, 520	ERDS2TJ392T	1/4W 3.9K	C411	ECBT1E103ZF	25V 0.01U			
R571	ERDS2TJ823T	1/4W 82K	C412	ECBT1E223ZF	25V 0.022U			
R572	ERDS2TJ124T	1/4W 120K	C413	ECEA1HKA2R2B	50V 2.2U			
R573	ERDS2TJ563	1/4W 56K	C414	ECEA1AU331	10V 330U			
R574	ERDS2TJ564	1/4W 560K	C415	ECBT1H102KB5	50V 1000P			
R575	ERDS2TJ223	1/4W 22K	C416	ECEA1HKA010B	50V 1U			

Note: The reference number SA represent the grease and tool used for this unit.

Ref. No.	Part No.	Part Name & Description	Remarks	Ref. No.	Part No.	Part Name & Description	Remarks
		CABINET PARTS LIST		A1	RAK-CH144WH	REMOTE CONTROL TRANSMITTER	
				A1-1	RKK0057-K	BATTERY COVER	
				A2	REE0499	SPEAKER CORD	
1	RKM0202D-K	CABINET		A3	REX0660	FLAT CABLE (MEDIUM)	
2	RHD30007-K1	SCREW		A4	REX0608	FLAT CABLE (SHORT)	
3	XTBS3+10JFZ1	SCREW		A5	REX0661	FLAT CABLE (LONG)	
4	RFKJECH530EK	BOTTOM BOARD ASS' Y	(E, EP)	A6	RJAO019-2K	AC POWER SUPPLY CORD	△ (SF) (E, EG, EP)
4	RFKJECH530EB	BOTTOM BOARD ASS' Y	(EB)	A6	VJA0733	AC POWER SUPPLY CORD	△ (SF) (VRD) (EB)
4	RFKJECH530EG	BOTTOM BOARD ASS' Y	(EG)	A7	RFKSECH530EK	INSTRUCTION MANUAL ASS' Y	(E)
4-1	RKA0011-3	FOOT		A7	RFKSECH530EB	INSTRUCTION MANUAL ASS' Y	(EB)
5	RKFO429-K	REAR GRILL		A7	RFKSECH530EG	INSTRUCTION MANUAL ASS' Y	(EG)
6	RKQ0089	P. C. B. SPACER		A7	RFKSECH530EP	INSTRUCTION MANUAL ASS' Y	(EP)
7	RMCO158	TRANSISTOR HOLDER		A8	RQA0013	WARRANTY CARD	
8	RFKGECH530EK	FRONT PANEL ASS' Y		A9	RQCB0169	SERVICE CENTER LIST	
9	RGK0714-K	ILLUMINATER		A10	RSA0012	AM LOOP ANTENNA	
10	RGL0282-Q	PANEL LIGHT		A10-1	RMN0244	ANTENNA HOLDER	
11	RGL0292-Q	POWER LIGHT		A10-2	XTN3+12AFZ	SCREW	
12	RGU1224-K	BUTTON, POWER		A11	RSA0007	FM INDOOR ANTENNA	
13	RGU1225-K	BUTTON, OPERATION		A12	SJP9009	POWER PLUG ADAPTOR	(EB)
14	RGW0207-1K	KNOB, MAIN				GREASE OR JIG/TOOL	
15	RGW0235-K	KNOB, MIC					
16	RHD26016	SCREW					
17	RMN0329	HOLDER		SA1	RFKX0002	COMPOUND GREASE	
18	SNE4021-1	NUT					
19	XTBS26+10J	SCREW					
20	XTBS3+8JFZ1	SCREW					
21	XTB3+10JFZ	SCREW					
22	XTB3+20JFZ	SCREW					
23	XTB3+8JFZ	SCREW					
24	XTW3+15T	SCREW					
25	RMN0191	HOLDER					
26	RWJ1808130XX	FLAT CABLE (8P) (W703)					
27	RWJ1812220QC	FLAT CABLE (12P) (W501)					
28	RWJ1803200QC	FLAT CABLE (3P) (W502)					
		PACKING MATERIALS					
P1	RPG2709	PACKING CASE (SYSTEM)	(E, EG, EP)				
P1	RPG2546	PACKING CASE (SYSTEM)	(EB)				
P2	RPG2708	PACKING CASE (CD-TUNER)					
P3	RPG2707	PACKING CASE (DECK)					
P4	RPG2706	PACKING CASE (AMPLIFIER)					
P5	RPN0893	PAD (CD-TUNER)					
P6	RPN0892	PAD (DECK)					
P7	RPN0891	PAD (AMPLIFIER)					
P8	SPP740	PROTECTION COVER					
P9	RPF0139	PROTECTION COVER					
P10	RPQ0522	SPACER					
P11	RPQ0541	SPACER					
		ACCESSORIES					

Cabinet Parts Location

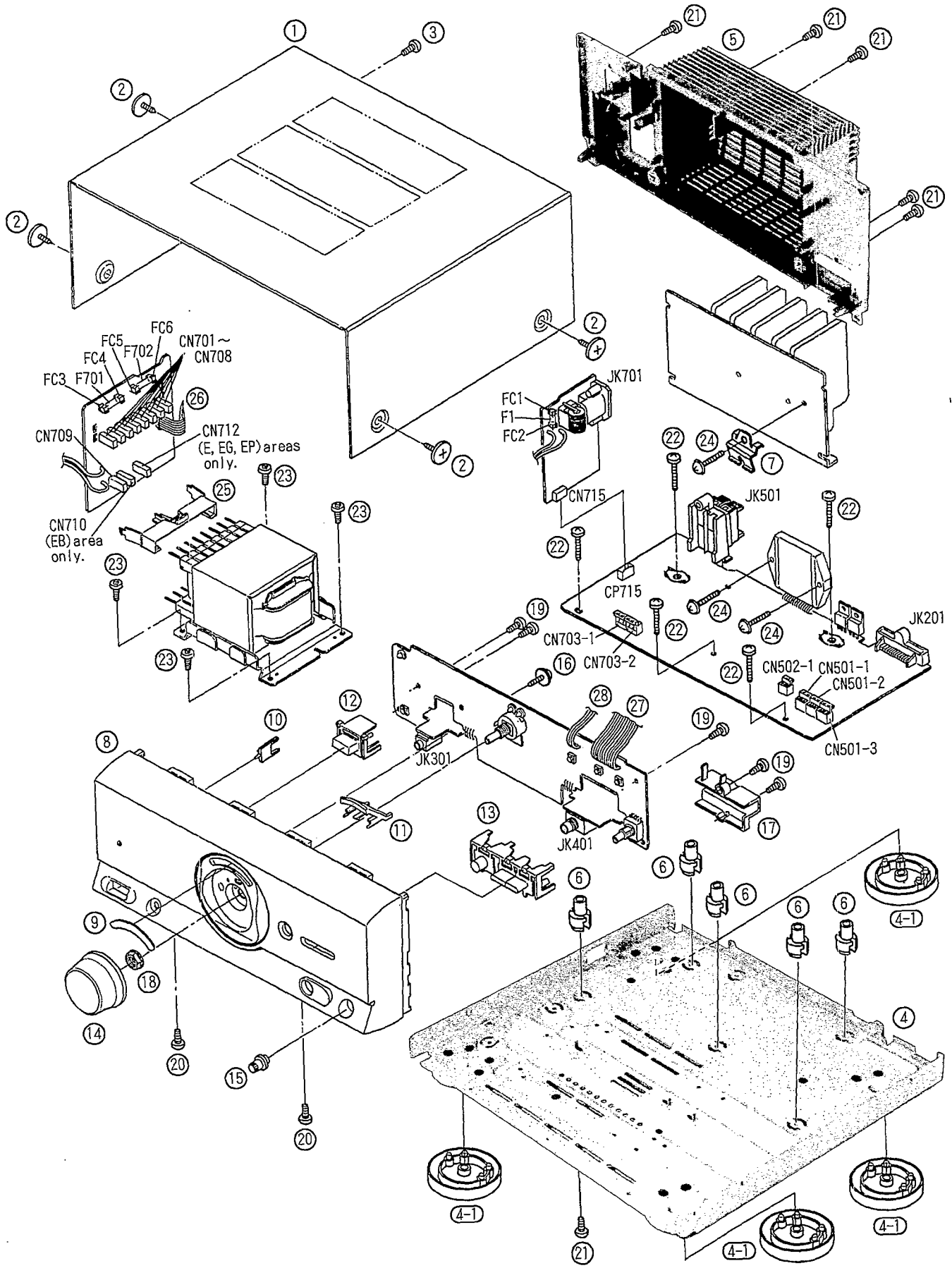

■ Packaging

